

# KENWOOD

PORTABLE MINIDISC PLAYER

## DMC-G3

---

### INSTRUCTION MANUAL

KENWOOD CORPORATION



#### *In regard to the power supply*

Use only the accessory AC adaptor or the optional car battery adaptor as external power supplies for this unit.

## **Unpacking**

Unpack the unit carefully and make sure that all accessories are put aside so they will not be lost. Examine the unit for any possibility of shipping damage. If your unit is damaged or fails to operate, notify your dealer immediately. If your unit was shipped to you directly, notify the shipping company without delay. Only the consignee (the person or company receiving the unit) can file a claim against the carrier for shipping damage.

We recommend that you retain the original carton and packing materials for use should you transport or ship the unit in the future.

Keep this manual handy for future reference.

## **Before applying power**

**⚠ Caution : Read this section carefully to ensure safe operation.**

Units are designed for operation as follows.

*U.S.A. and Canada* ..... *AC 120 V only*





## **Safety precautions**

**⚠ Caution : Read this section carefully to ensure safe operation.**

**WARNING: TO PREVENT FIRE OR ELECTRIC SHOCK, DO NOT EXPOSE THIS APPLIANCE TO RAIN OR MOISTURE.**

# Contents

Caution: Read the pages marked  carefully to ensure safe operation.

Introduction .....	2
 Before applying power .....	2
 Safety precautions .....	2
 Contents .....	3
 IMPORTANT SAFEGUARDS .....	4
Before operation .....	6
For pleasant use .....	7
Names and functions of parts .....	8
 Power sources .....	10
Using the AC adaptor .....	10
Charging the rechargeable battery .....	11
Playback (Basics) .....	14
Preparing the unit for playback .....	14
Sequential playback from the first track .....	16
Stopping playback .....	17
Turning the power off .....	17
Removing the MD .....	17
Playback (Application) .....	18
Searching for the desired track (SEARCH) .....	18
Playback from the desired track (SKIP) .....	19
Skipping to another track during playback (SKIP) .....	19
Repeated playback .....	20
Changing the tone (BASS BOOST) .....	21
Convenient functions .....	22
Activating the operating tone (Beep) .....	22
Changing the display .....	23
Avoiding faulty operation (HOLD) .....	24
Using the clip .....	24
MD system .....	25
Setting AUTO POWER SAVE .....	26
In case of difficulty .....	28
Troubleshooting .....	28
Meaning of display messages .....	28
Reference .....	29
Specifications .....	30

**⚠ Caution: Read this page carefully to ensure safe operation.**

## **IMPORTANT SAFEGUARDS**

Please read all of the safety and operating instructions before operating this unit. For best results, follow all warnings placed on the unit and adhere to the operating and use instructions. These safety and operating instructions should be retained for future reference.

- 1. Power sources** — The unit should be connected to a power supply only of the type described in the operating instructions or as marked on the appliance.
- 2. Power-cord protection** — Power-supply cords should be routed so that they are not likely to be walked on or pinched by items placed upon or against them, pay particular attention to cords at plugs, convenience receptacles, and the point where they exit from the unit.
- 3. Enclosure removal** — Never remove the enclosure. If the internal parts are touched accidentally, a serious electric shock might occur.
- 4. Drop** — Do not drop the unit or apply strong shock to it. (Damage due to dropping the unit is not covered by the warranty.)
- 5. Ventilation** — Avoid hindering the ventilation of the unit by covering it with a cloth, etc.
- 6. Abnormal smell** — If an abnormal smell or smoke is detected, immediately turn the power OFF and pull out the power cord. Contact your dealer or nearest service center.
- 7. Heat** — Avoid placing the unit under direct sunlight or near a source of heat such as heating equipment. Particularly, never leave it in an automobile or on the dashboard.
- 8. Temperature** — The unit may not function properly if used at extremely low, or freezing temperatures. The ideal ambient temperature is above +5°C (41°F).
- 9. Water and moisture** — The unit should not be used near water — for example, near a bathtub, washbowl, kitchen sink, laundry tub, in a wet basement, or near a swimming pool, etc.
- 10. Dust and moisture** — Avoid places where is dusty or where the humidity is high.
- 11. Vibrations** — Avoid placing the unit on an unstable place such as a shelf or in a place subject to vibrations.

⚠ **Caution:** Read this page carefully to ensure safe operation.

12. **Magnetic fields** — Keep the unit away from sources of magnetic fields such as TV sets, speaker systems, radios, motorized toys or magnetized objects.
13. **Cleaning** — Do not use volatile solvents such as alcohol, paint thinner, gasoline, or benzine, etc. to clean the cabinet. Use a clean dry cloth.
14. **Nonuse periods** — The power cord of the unit should be unplugged from the outlet when left unused for a long period of time.
15. **Damage requiring service** — The unit should be serviced by qualified service personnel when:
  - A. The power-supply cord or the plug has been damaged.
  - B. Objects have fallen, or liquid has been spilled into the unit.
  - C. The unit has been exposed to rain.
  - D. The unit does not appear to operate normally or exhibits a marked change in performance.
  - E. The unit has been dropped, or the enclosure damaged.
16. **Servicing** — The user should not attempt to service the unit beyond that described in the operating instructions. All other servicing should be referred to qualified service personnel.
17. **CAUTION** — TO PREVENT ELECTRIC SHOCK DO NOT USE THE AC PLUG WITH AN EXTENSION CORD, RECEPTACLE OR OTHER OUTLET UNLESS THE BLADES CAN BE FULLY INSERTED TO PREVENT BLADE EXPOSURE.

## **WARNING**

Lithium battery.

Danger of Explosion if handled careless.

Replace the Battery with the same manufacturer and type.

Return the old battery to the supplier.

## Special features

### 9.5 Hours of Continuous Playback

9.5 hours of continuous Playback are possible, with only the specially provided rechargeable battery.

### Sound-skip prevention Memory

Equipped with Sound-skip prevention memory, this unit has a vibrationproof design for outdoor use.

### Remote Control with Liquid Crystal Display with EL (Electro Luminescence) Backlight

The remote control has a liquid crystal display in the image of a digital clock with a blue backlight.

### All Operations Can Be Performed by Remote Control

All operations - Playback, track search, sound quality changeover, and so on - can be performed by remote control.

### Written Data Can Be Displayed on the Remote Control \*

When a disc with recorded disc name or track titles is played back, the disc name and track titles can be displayed on the remote control.

(\* When an MD with recorded data is played back)

## Accessories

Check that the following accessories are present.

AC adaptor (1)

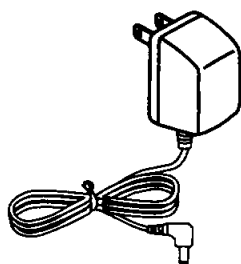

Remote control unit

(1)

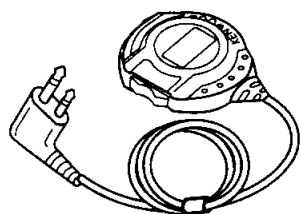

Stereo headphone (1)

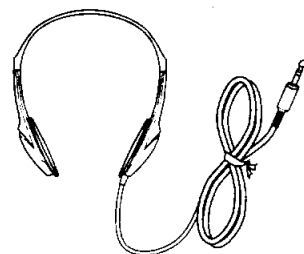

Rechargeable battery

(1)

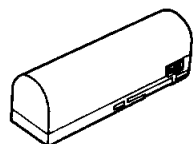

Carrying case (1)

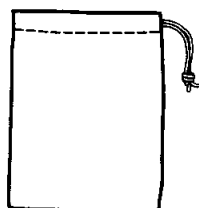

## Simple care

### When dirty

- Wipe with a dry, soft cloth.

If the unit is very dirty, moisten the cloth slightly and wipe off the dirt. Afterwards, make sure you wipe the unit dry with a dry cloth.

### Taking care of plugs etc.

- Always keep the plugs of headphones etc. clean. Dirty plugs can cause noise or failure of remote control operation.

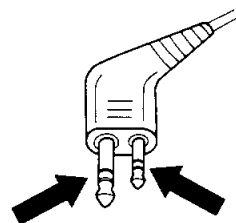

1. Do not use chemicals like benzine, thinner, etc., as they can cause deterioration and discoloration.
2. Do not apply oil to the unit, for this will cause it to malfunction.

## Beware of condensation

When water vapor comes into contact with the surface of cold material, water drops are produced. If condensation occurs, correct operation may not be possible, or the unit may not function correctly.

This is not a malfunction, however, and the unit should be dried.

(To do this, turn the POWER switch ON and leave the unit as it is for several hours.)

### Be especially careful in the following conditions:

- When the unit is brought from a cold place to a warm place, and there is a large temperature difference.
- When a heater starts operating.
- When the unit is brought from an air-conditioned place to a place of high temperature with high humidity.
- When there is a large difference between the internal temperature of the unit and the ambient temperature, or in conditions where condensation occurs easily.

## Main Unit

### Front/Top

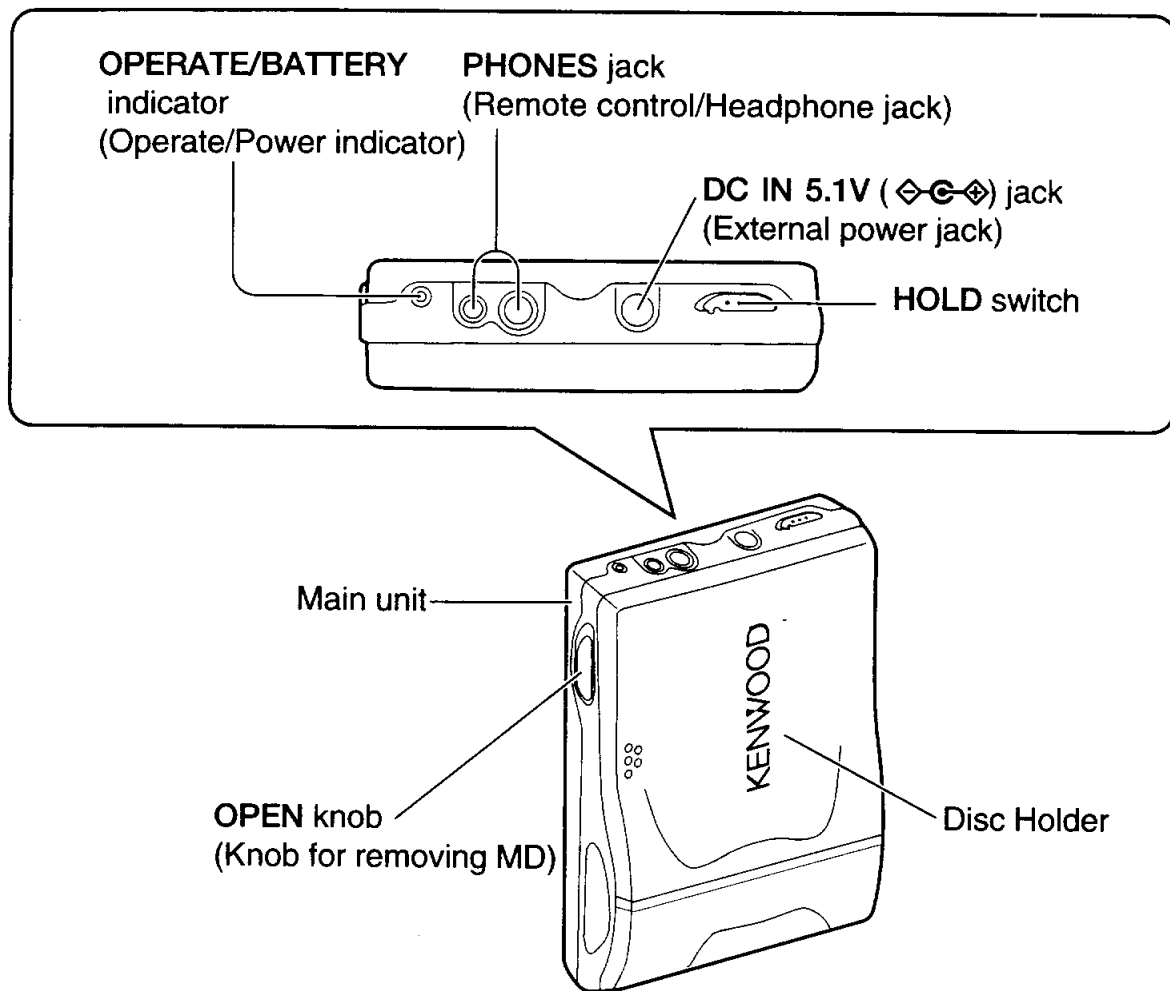

### Rear

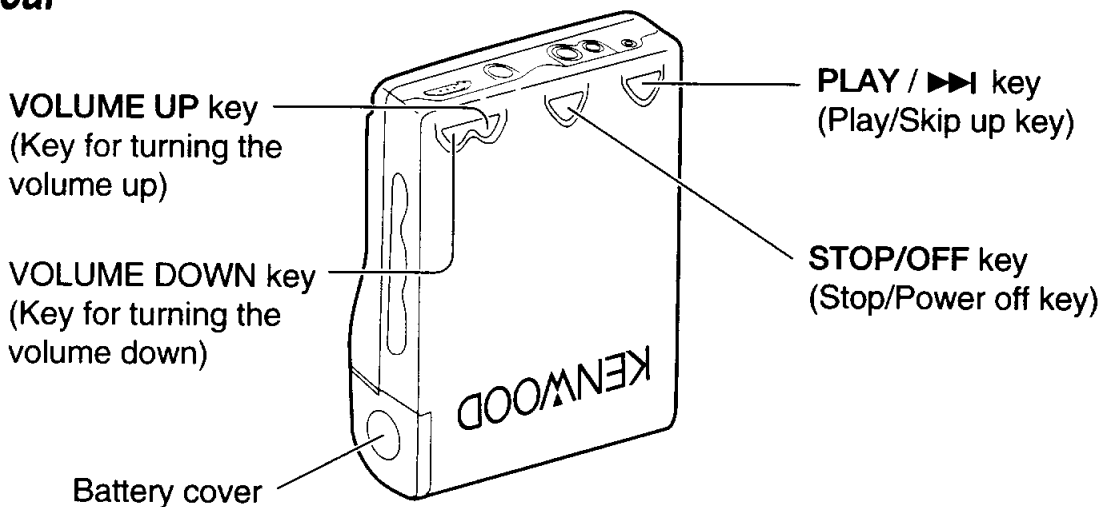



# Remote Control

Functions marked with an asterisk (\*) indicate operations performed in SHIFT Mode.

## Liquid Crystal Display

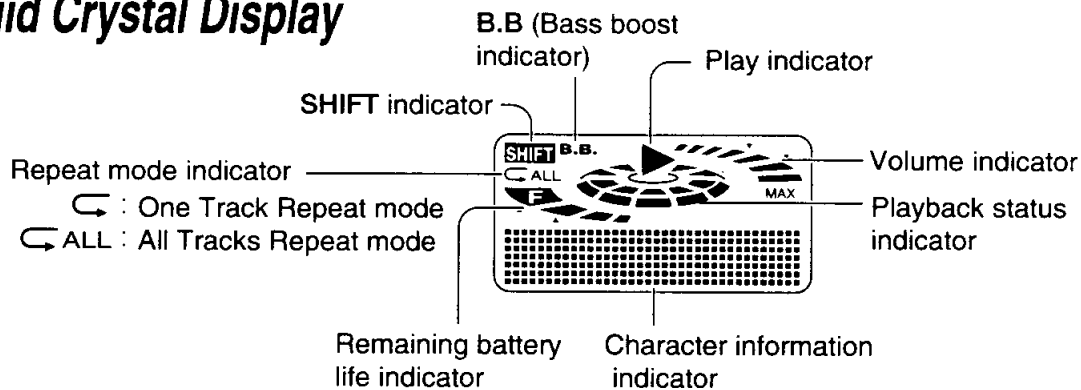

## Front

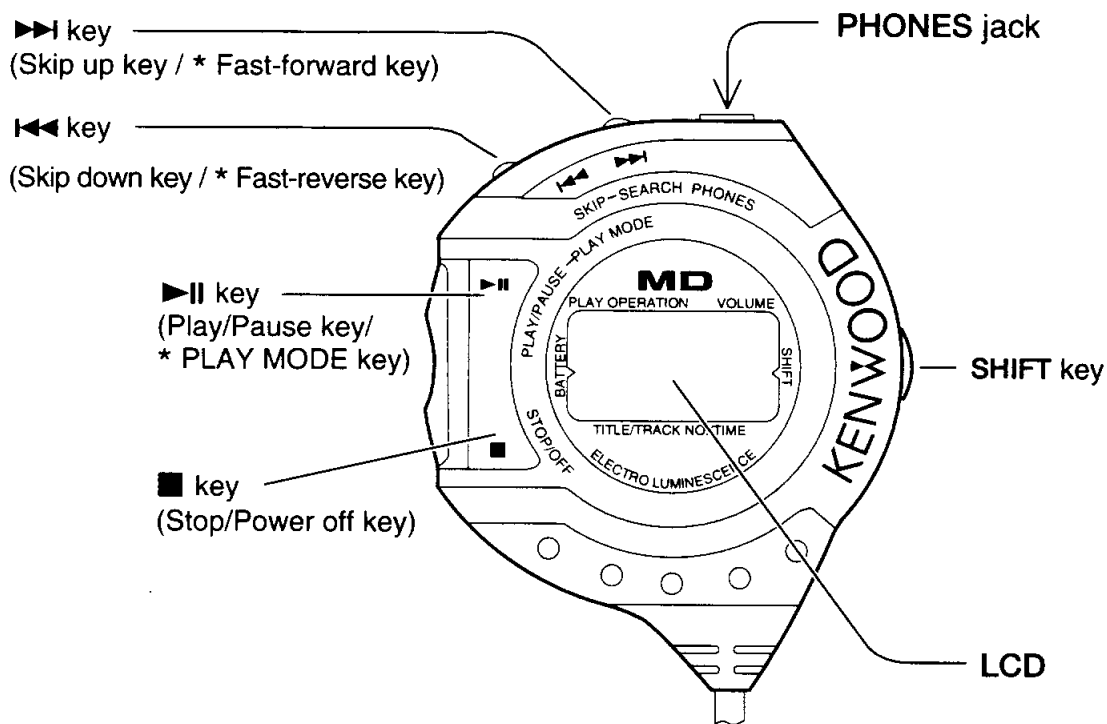

## Rear

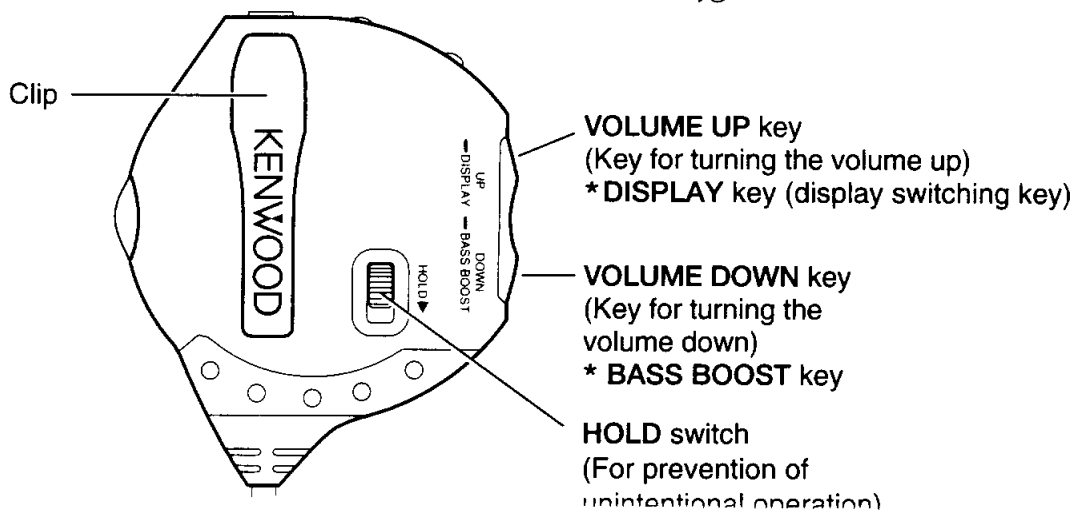

⚠ Caution: Read this page carefully to ensure safe operation.

## Using the AC adaptor

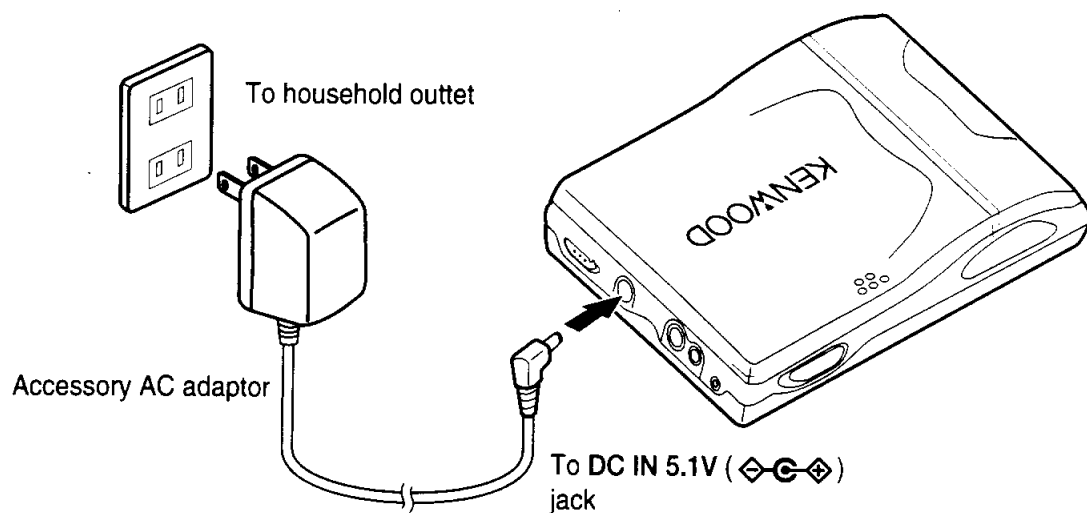

## For use in a car

Please use the separately sold car battery adaptor (DC-C60) and car cassette adaptor (CAC-2) for listening connected to a car stereo system. Never connect the unit to the external input terminal (AUX input terminal etc.) of a car stereo system, as this will cause malfunctions.

⚠ Caution: Read this page carefully to ensure safe operation.

## Charging the rechargeable battery

- The battery is not fully charged, so charge the battery according to the following procedure before you use the unit.
- Charge the battery with the power to the unit turned OFF. (The battery is not charged while the unit is in operation.)
- When the optional battery case is attached, remove it before charging the battery.

### 1 Open the rechargeable battery cover.

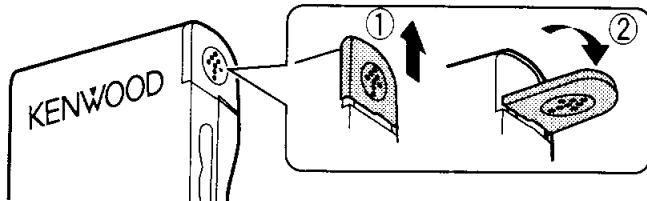

- ① Slide the battery cover up.
- ② Open the battery cover.

### 2 Insert the rechargeable battery and close the cover.

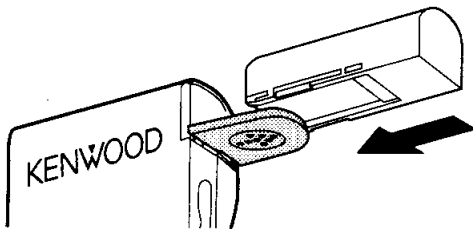

Insert in the direction of the arrow.

### 3 Connect the specially provided AC adaptor.

To household outlet

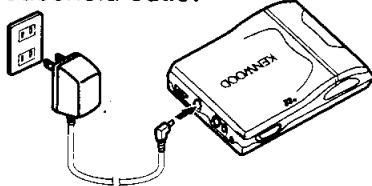

"Using the AC adaptor" → 10

### 4 Press the unit's STOP/OFF key.

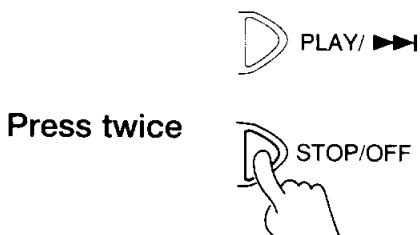

Flashing while charging is in progress.

Extinguished when charging is completed.

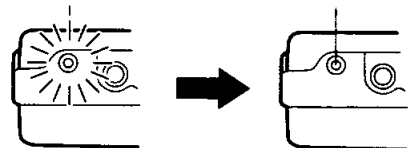

OPERATE/BATTERY indicator

⚠ **Caution:** Read this page carefully to ensure safe operation.

## Rechargeable battery (NB-L9)

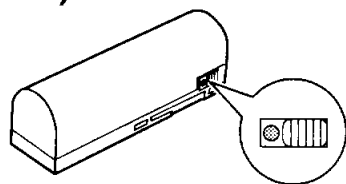

Charge confirmation mark

The battery is provided with a charge confirmation mark. It is convenient to set this to the unmarked side for a charged battery and the red circle for a used battery.

## Charging time

- The battery can be fully charged in about 5 hours.
- When charging is started, the unit's power indicator will start to flash, and it will be extinguished when charging has been completed.

Flashing while charging is in progress.

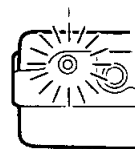

Extinguished when charging is completed.

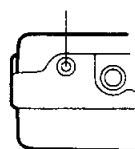

OPERATE/BATTERY indicator

## Battery life

A fully charged battery can be used for about 9.5 hours.\*

\* This value is a standard value for continuous use/charging in an ambient temperature of 25°C. Battery life varies depending on the use environment and temperature.

## Checking the remaining battery life and charge status

For handy reference, the remaining battery life is indicated on the display while the unit is in operation.

- As the remaining battery life diminishes, the scale graduations are extinguished one at a time. Please recharge the battery when the remaining charge is very low.

When the battery charge has been used up completely, the display will show "Lo BATT", the remaining battery charge indication will flash, and the power will be switched off automatically.

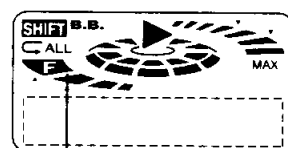

Remaining Battery Life Indicator



After battery has been charged

Flashes when battery needs to be recharged

- The indicator is not displayed when the AC adaptor is being used.

⚠ Caution: Read this page carefully to ensure safe operation.

## ***Cautions regarding use of rechargeable (lithium ion) battery***

- The battery is a rechargeable lithium ion battery. Because of the properties of this battery, it must be recharged at least once every 3 months, even if it is not used.
- The battery can be recharged about 300 times.
- Do not use any battery other than the specially provided rechargeable battery. Use of another battery will damage the unit.
- When the service life of the battery is about half its normal life even after it has been recharged, replace the battery with a new one.
- After the battery has been charged, the unit may be used with the AC adaptor connected. But if the unit is not used for a long time (such as overnight charging), disconnect the AC adaptor.
- When the battery is being charged or when the unit is being used, make sure the surrounding temperature is 10°C - 30°C. The battery's service life is shortened in cold locations.
- A small amount of power is used even when the unit is turned OFF. If the unit is not used for a long time, therefore, remove the battery and store it in a safe place.
- Keep the terminal part free of foreign objects.

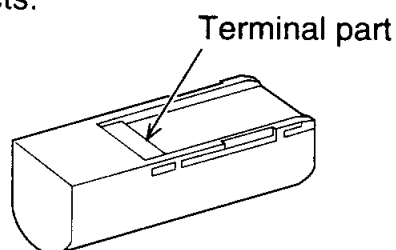

During battery charging or use of the unit, the battery may become warm. This is normal and does not indicate a malfunction.

## ***REQUIREMENT BY NEDERLAND GAZETTE***

Batteries are supplied with this product. When they empty, you should not throw away. Instead, hand them in as small chemical waste.

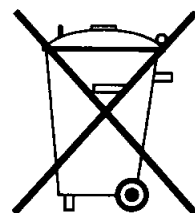

## Preparing the unit for playback

### 1 Set the battery in place or connect the AC adaptor.

When using the rechargeable battery

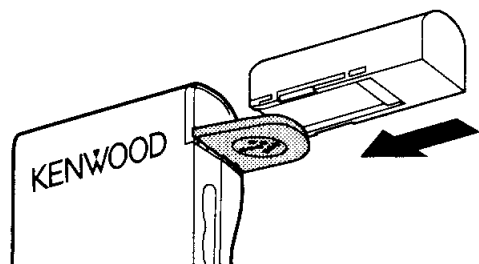

When using the AC adaptor

To household outlet

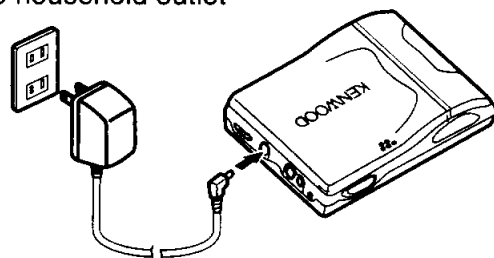

### 2 Connect the remote control and headphone.

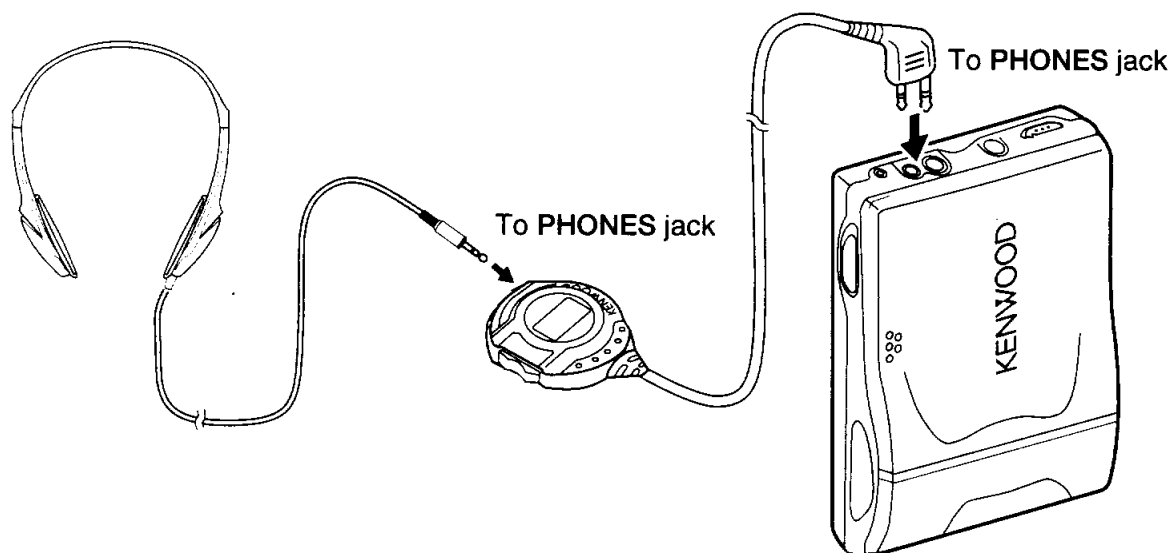

- The optional stereo headphones with miniplug can also be used.



1. Do not connect a remote control other than the accessory remote control unit.
2. Insert the plug securely into the jack.
3. Always hold the plug to pull it. Pulling on the cord to pull the plug can cause trouble.

### 3 Insert a recorded MD.

- ① Move the **OPEN** knob in the direction of the arrow.

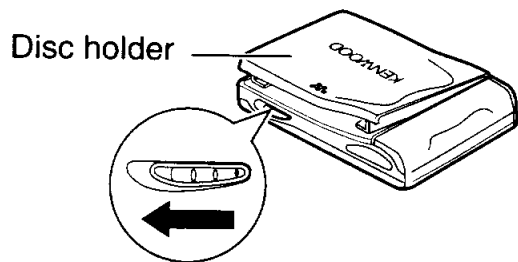

- ② Open the disc holder with your hand.

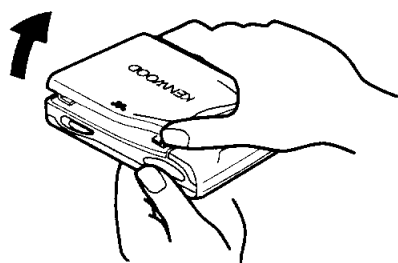

- ③ Insert the MD in the direction of the arrow mark on the disc.

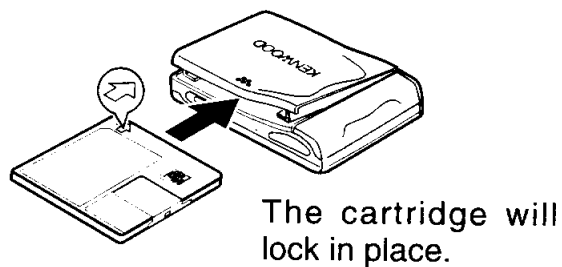

- ④ Close the disc holder with your hand.

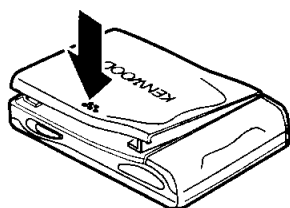

- The disc holder will open slightly.

- Do not force the disc holder open, for this will damage it.

- Press on the middle part of the MD when inserting it.
- If there is some obstruction and insertion is not smooth, do not use force. This can cause trouble. If insertion is difficult, remove the MD and try to insert it again.

- If the disc holder does not close securely, repeat the procedure from step ①.

- Operation for listening to a track from the start.
- MDs recorded in monaural mode for a long time can also be played back.

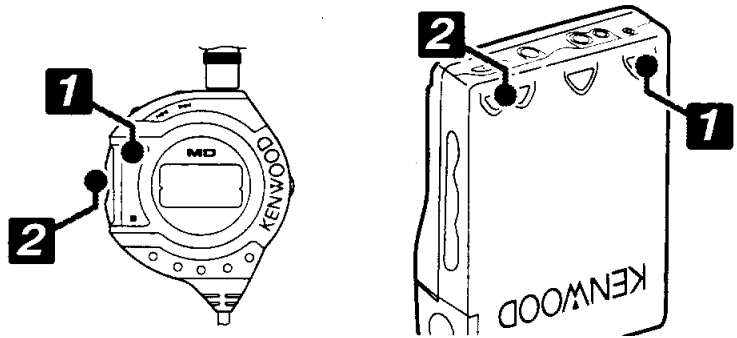

## Sequential playback from the first track

### HOLD Switch

Both the unit and the remote control are equipped with a HOLD switch. To operate the keys, release the HOLD switch first. Key operation is not accepted when HOLD status is engaged.

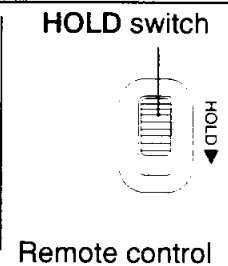
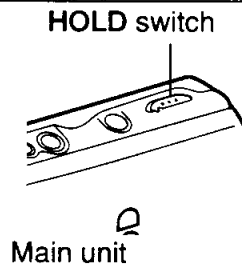
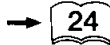

## 1 Start playback

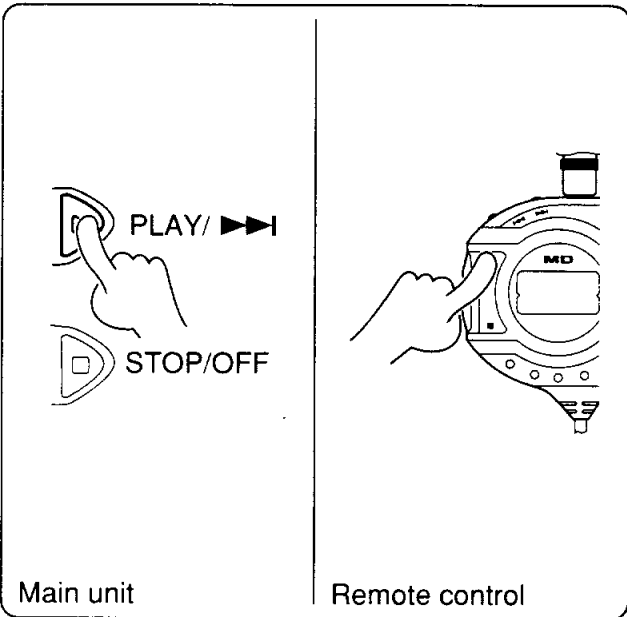

- Power comes ON and Playback starts from the first song. (The unit's OPERATE/BATTERY indicator is lit.)

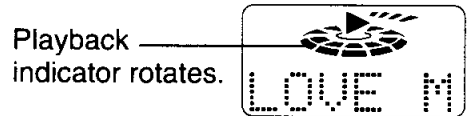

During Playback, track titles are scrolled (from right to left).

- Track titles are not displayed if the MD has no track titles on it. In this case, "NO TITLE" is first displayed and then the track number or elapsed time is displayed.
- When the ▶|| key on the remote control is pressed, Playback will temporarily stop (PAUSE). Pressing the key again will resume Playback from the stopped position.
- After the last track is over, Playback will stop.

## 2 Adjust the volume

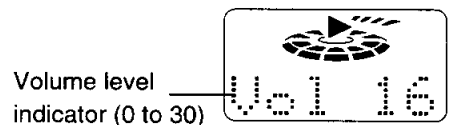
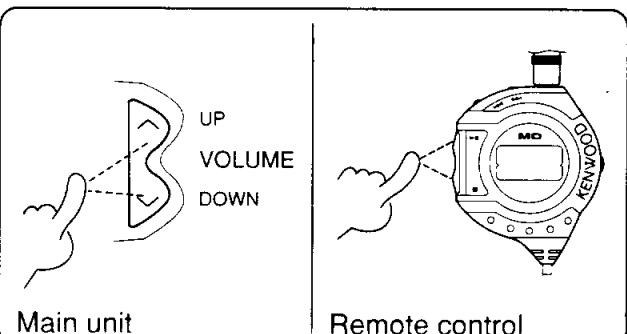

- Set the volume level between 0 and 30.
- Once the volume has been adjusted, it will be stored in memory until it has been changed, even after the power has been turned OFF.



## Stopping playback

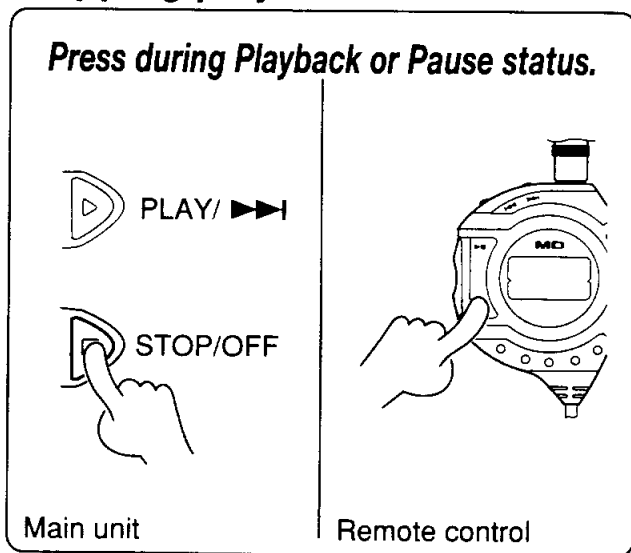

- Playback will stop when the **STOP/OFF** key on the unit or the  key on the remote control is pressed during Playback or Pause status.

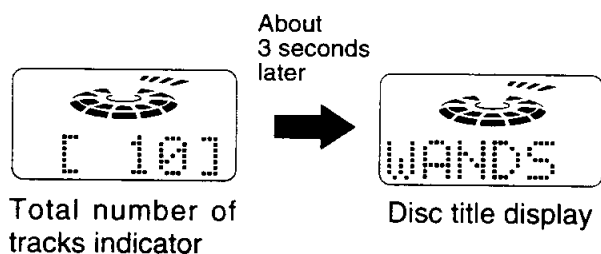

## Turning the power off

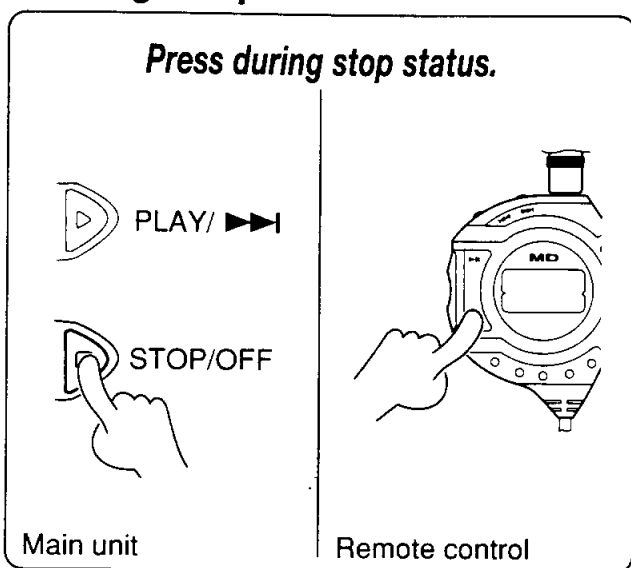

- The unit can be turned off by pressing either the **STOP/OFF** key on the unit or the  key on the remote control during stop status.
- The power will automatically turn off if the unit is not operated for about 3 minutes after it has stopped.



When Playback is started again, it will start from the start of the track that was being played back when playback was stopped. (Playback will start from the first track if the MD has been removed from the unit.) This is called the "RESUME" function.

## Removing the MD

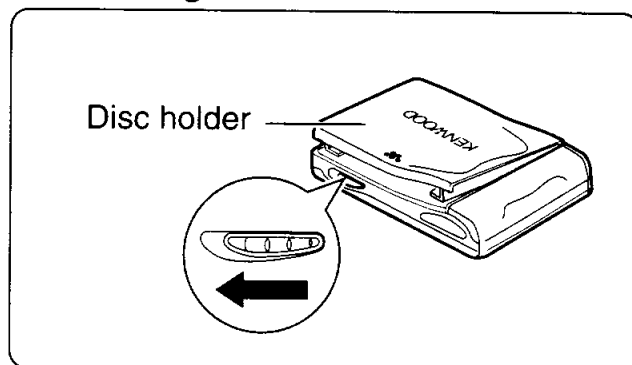

- After the power is turned off, slide the **OPEN** knob in the direction of the arrow and remove the MD.

Fast Forward and fast-reverse operations can be performed while listening to music (only by remote control operation).

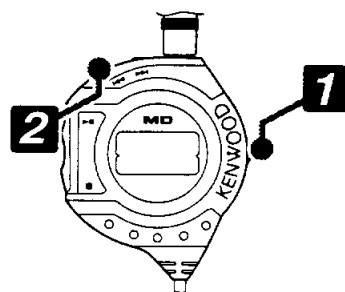

## Searching for the desired track (SEARCH)

### 1 Press the SHIFT key

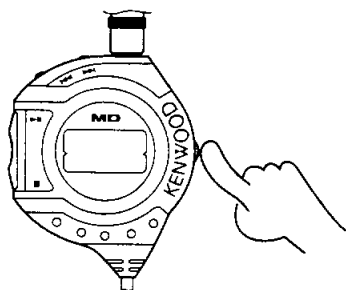

- When the **SHIFT** key is pressed, the **◀◀** and **▶▶** keys will engage fast forward and fast-reverse modes, respectively.

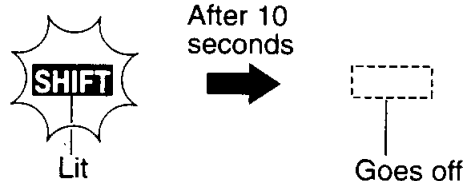

If the following operations are not performed within 10 seconds while in **SHIFT Mode**, the original mode will be restored.

### 2 Press **◀◀** key or **▶▶** key

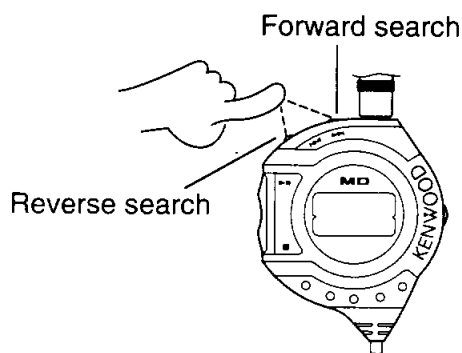

For Forward search : keep pressing the **▶▶** key during playback.

For Reverse search : keep pressing the **◀◀** key during playback.

- When you lift your finger off the key, normal playback will be resumed.



1. In fast forward mode, stop status is engaged when the end of the last track is reached.
2. In reverse mode, playback starts when the start of the first track is reached.
3. Depending on recording conditions, sound interruptions may occur during a fast forward/reverse operation.

## Playback from the desired track (SKIP)

From stop status you can skip to the start of the track you want to hear. (only by remote control operation).

Press **◀◀** key or **▶▶** key

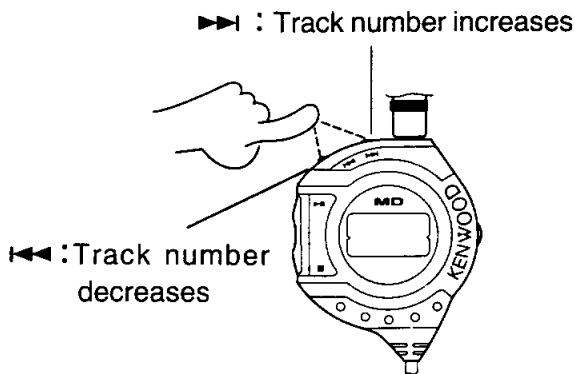

- The track number changes each time the button is pressed.
- Playback starts from the selected track.

Rotates faster than normal



- When the **▶▶** is pressed repeatedly and the last track is reached, the last track will be played back.
- When the **◀◀** is pressed repeatedly and the first track is reached, the first track will be played back.

## Skipping to another track during playback (SKIP)

During Playback of one track you can skip to another track you want to hear.

Press **◀◀** key or **▶▶** key

▶▶ : Track number increases

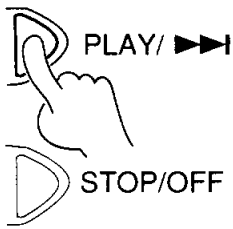

Main unit

▶▶ : Track number increases

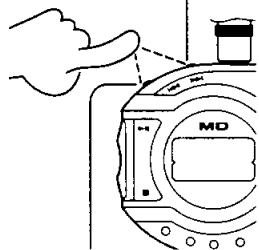

◀◀ : Track number decreases

Remote control

- When the unit's **PLAY/▶▶** key or the **▶▶** key on the remote control is pressed, playback will skip to the start of the subsequent track.
- Each time the key is pressed, Playback will skip to the next track.
- When the **◀◀** key on the remote control is pressed, playback will skip to the start of the track being played back.
- Each time the key is pressed, playback will skip to the previous track.



The unit is not equipped with a function to lower the track number. In order to lower the number, use the remote control.

One track or all tracks can be played back repeatedly (only by remote control operation).

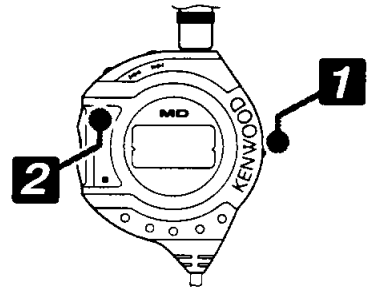

## Repeated playback

### 1 Press the SHIFT key

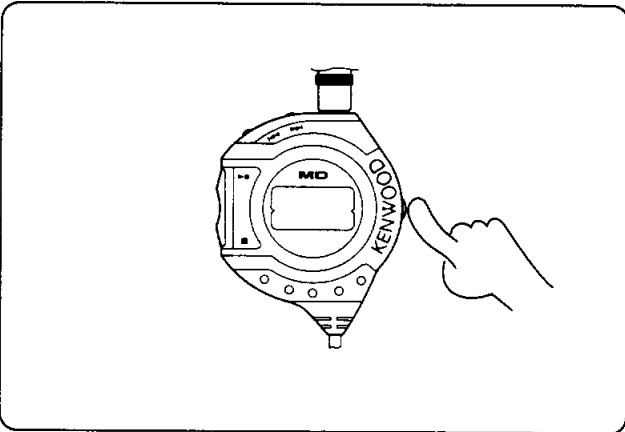

- When the SHIFT key is pressed, the PLAY/▶|| key will activate PLAY MODE, and changeover to Repeat Playback will be possible.

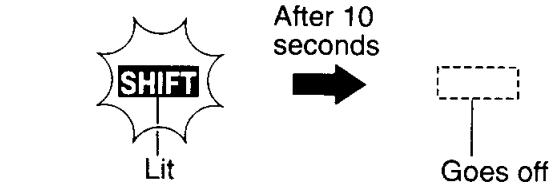

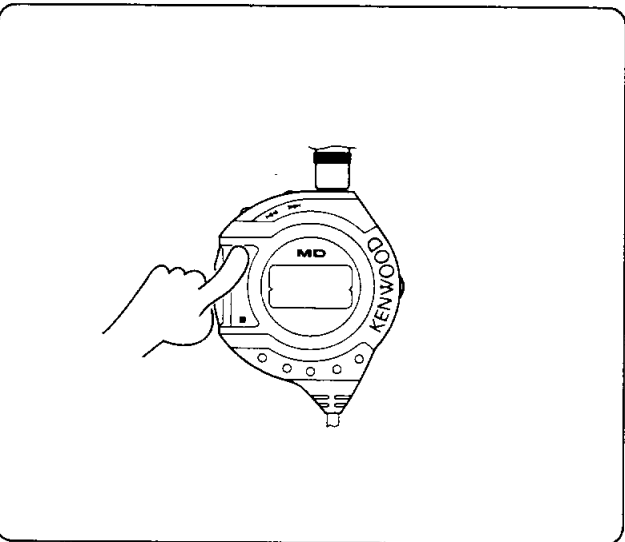

- If the following operations are not performed within 10 seconds while in SHIFT Mode, the original mode will be restored.

### 2 Press the ▶|| key



Each press of the key switches the mode as follows

#### Repeat mode indication

- ① Not lit : Released
- ②  : The track being played will be played repeatedly.
- ③  ALL : All tracks of the disc will be played repeatedly.

#### Character information indication

- ① OFF : Released
- ② ONE : The track being played will be played repeatedly.
- ③ ALL : All tracks of the disc will be played repeatedly.

- The character information indication goes out after several seconds.



1. After stop status has been engaged during repeat playback, when playback is resumed, repeat playback will start from the point where playback was stopped.
2. After the disc has been removed, playback will start normally, from the first track.

The bass can be boosted in 3 stages (only by remote control operation).

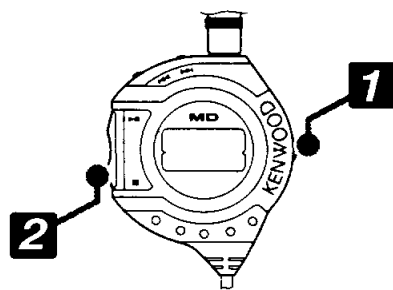

## Changing the tone (BASS BOOST)

### 1 Press the SHIFT key

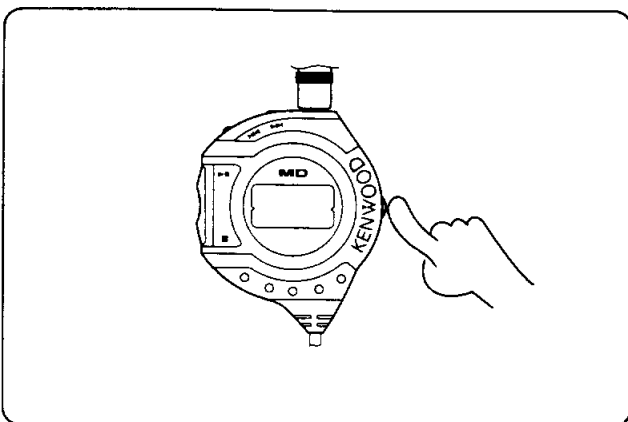

- When the SHIFT key is pressed, the VOLUME DOWN key will activate BASS BOOST mode.

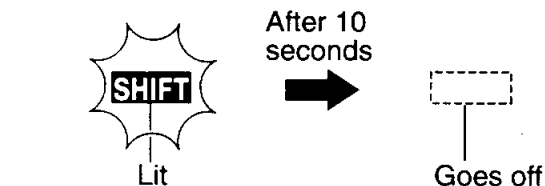

- If the following operations are not performed within 10 seconds while in SHIFT Mode, the original mode will be restored.

### 2 Press the BASS BOOST key

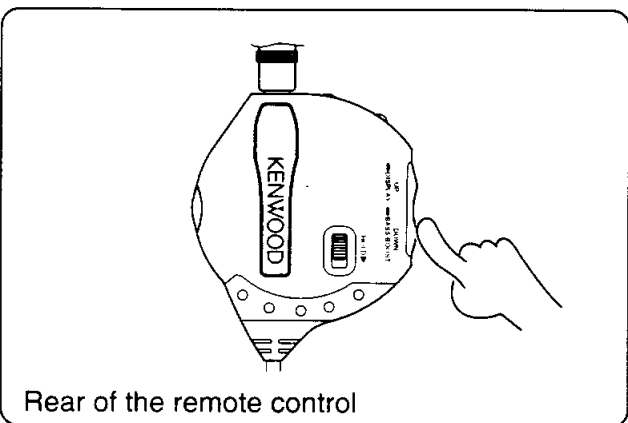

Each press of the key switches the mode as follows

- ① BASS 0:Cancel
- ② BASS 1:Bass is boosted slightly.
- ③ BASS 2:Bass is boosted more.
- ④ BASS 3:Bass is boosted even more.

- The indication goes out after several seconds.

**Note** When the bass is boosted, raising the volume excessively will result in sound distortion. If this happens, either lower the bass level or the volume level.

## Activating the operating tone (Beep)

The operating tone ( →  ) can be activated or deactivated.

### Deactivating the Operating Tone

- 1 Press the SHIFT key
  - 2 Keep pressing the BASS BOOST key until "BP off" is displayed.
- The operating tone will beep twice.
  - The operating tone will not beep even when an operation key is pressed.

### Activating the Operating Tone

- 1 Press the SHIFT key
  - 2 Keep pressing the BASS BOOST key until "BP on" is displayed.
- The operating tone will beep once.
  - The operating tone will beep when an operation key is pressed.



The operating tone's status - activated (BP on) or deactivated (BP off) - will be stored in memory even when the power is turned OFF.

Disc name, track titles, performance times, and other data on the MD can be displayed.

- The disc name is displayed during STOP operation.
- The title of the track being played is displayed during PLAY operation.  
(only by remote control operation).

## Changing the display

### 1 Press the SHIFT key

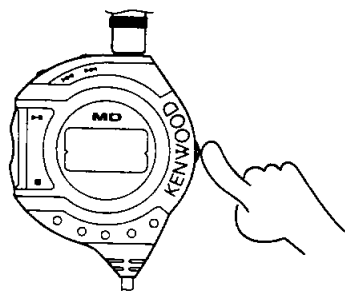

- When the SHIFT key is pressed, the VOLUME UP key will activate DISPLAY mode.

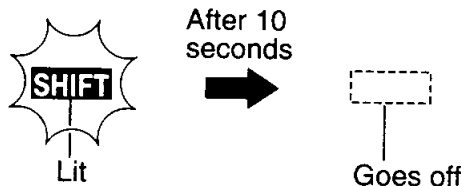



- If the following operations are not performed within 10 seconds while in SHIFT Mode, the original mode will be restored.

### 2 Press the DISPLAY key



#### When pressed during STOP operation:

Each press of the key switches the mode as follows

- ①  Disc name  
WANDS
- ②  Total number of tracks  
[ 10 ]
- ③  Total playing time  
42:58

#### When pressed during PLAY operation:

Each press of the key switches the mode as follows

- ①  Title of track being played  
LOVE M
- ②  Number of track currently being played  
009
- ③  Elapsed time of track currently being played  
3:07



Track titles or disc names are not displayed if they are not recorded on the disc.

## Avoiding faulty operation (HOLD)

The HOLD function prevents the unit from operating if a key is pressed unintentionally in situations such as when the unit is being used on a train.

- The HOLD function also prevents the power from coming ON unintentionally when carrying the unit with the power OFF, thus saving battery wear. (Both the main unit and remote control should be carried with the HOLD function engaged.)

### Activating HOLD status for main unit keys only

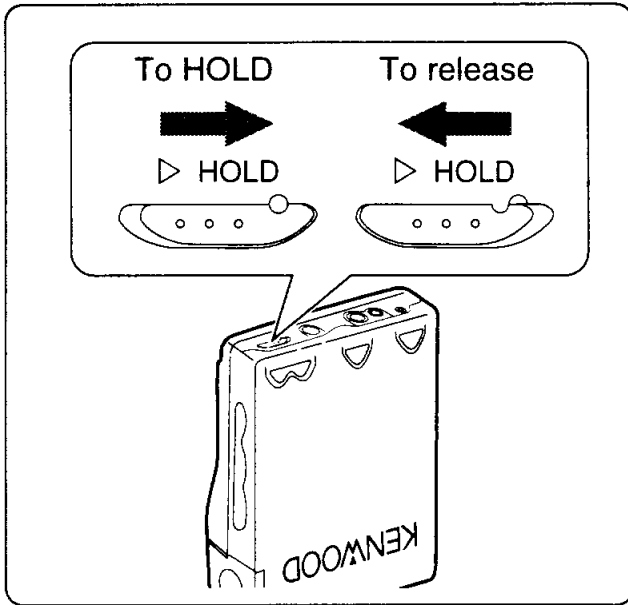

- Slide the ▷ HOLD switch on the unit toward the HOLD side.
- Release the ▷ HOLD switch on the unit when you want to operate the unit.

### Activating HOLD status for remote control keys only

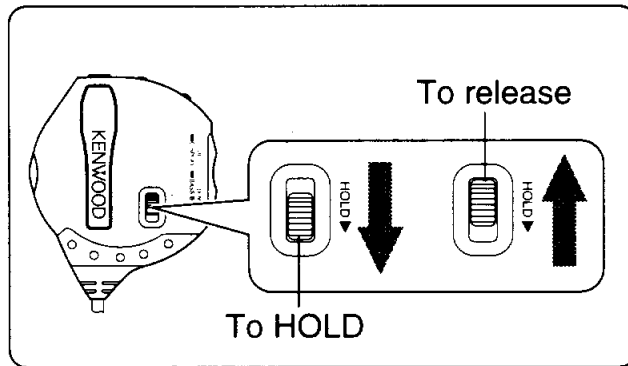

- Slide the HOLD ▷ switch on the remote control toward the HOLD side.
- Release the HOLD ▷ switch on the remote control when you want to operate the unit by remote control.

## Using the Clip

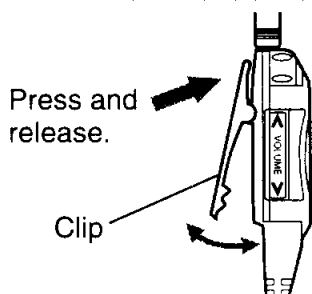

- The remote control unit can be clipped to a bag or a pocket.



## What is a Mini Disc

Learning the basics of MDs will help you understand their operation.

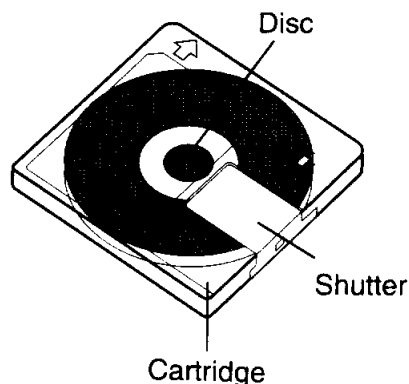

### Small Size

- With a diameter of 64mm, the disc fits into a cartridge 68mm x 72mm in size, so it is easy to keep clean and damage-free, and it can be handled easily.

### Digital Recording and Playback

- Since it is recorded with the same digital method used for CDs, the sound quality rivals that of the CD.

### Up to 74 Minutes of Stereo Recording or Playback

- Up to 148 minutes of monaural Recording or Playback and up to 74 minutes of stereo Recording or Playback are possible.

## Types of MDs

Two types of MDs are available: MDs for Playback only and MDs for Recording and Playback.

### Playback Only Mini Disc

This disc cannot record.

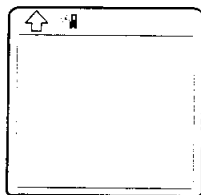

- Commercial music software and other Playback Only discs are used.
- An optical pickup similar to that of the CD is used for Playback.

### Recordable Mini Disc

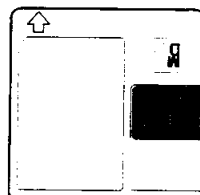

- A laser beam and a magnetic device are used to record on a recordable blank disc. Also, since the recording is digital, sound quality will not deteriorate, no matter how many times the disc is recorded.

## The New Technology of MDs

### Sound Compression Technology

#### ATRAC (Adaptive TRansform Acoustic Coding)

The MD is about half the size of a CD but has about the same recording time. This is due to sound compression technology (ATRAC) based on the science of acoustic psychology. With this technology, sound data can be reduced by about 1/5, without losing acoustic sound quality.

## High-Speed Song Selection (TOC)

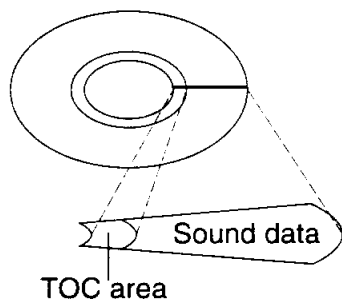

With an MD, a desired song can be selected at a high speed, as in the case of a CD. This is because the song numbers and titles are stored in the so-called TOC area, and based on these data, a song can be selected instantly.

The TOC (Table of Contents) area functions similarly to the Table of Contents in a book.

## Sound-skip prevention memory

During Playback the unit accumulates signals in its memory for a given period of time. As a result, music can be played back without sound skips - even when the unit receives an impact from an external source or when the signal from the optical pickup is interrupted.

### During Normal Playback

- Sound is stored in the memory during Playback.

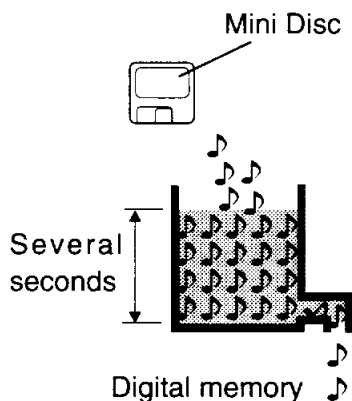

### When Vibration Occurs

- When the readout from disc is interrupted momentarily due to vibration or shock, the reproduced sound from the memory will not be interrupted.

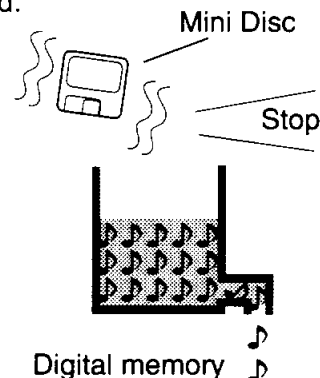

## Setting AUTO POWER SAVE

Normally, "auto PS" mode is used to keep the battery power consumption down. Please set to "PS off" mode when listening at places with many vibrations or shocks.

- ① Press the **SHIFT** key
- ② Keep pressing the **▶||** key until the display appears.

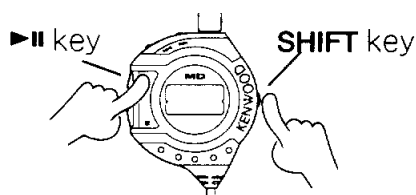

Each time keys are pressed in order, the following functions are changed over.

- ① "auto PS" : Normal sound-skip prevention memory mode
- ② "PS off" : Boosted sound-skip prevention memory mode

## Handling of Mini Disc

Since the MD is in a cartridge, it can be handled without worrying about dirt or fingerprints. But soiling, warping, or other damage to the cartridge will result in faulty operation. Take the following precautions to ensure that you will always be able to enjoy the music on your MDs.

### Do Not Touch the MD Directly

- Do not open the shutter and directly touch the MD. Forcing the shutter open will damage it.

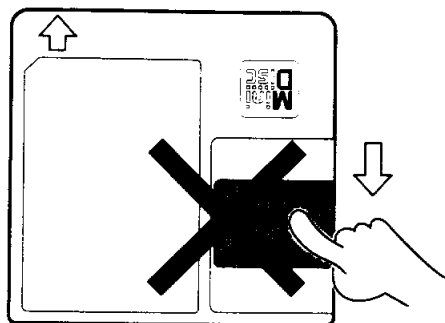

### Storage Location

- Do not store MDs in direct sunlight or in hot locations such as car interiors or in humid locations.
- Do not leave MDs on a beach or other location where sand or dirt can enter the cartridge.

### Care and Maintenance

- Using a dry cloth, wipe dirt or dust off the cartridge at regular intervals.

## Affixing the Label

- When affixing a label on the cartridge, take the following precautions and affix it properly.
- If the label is not properly affixed, it may get stuffed into the cartridge, making it impossible to remove the disc.

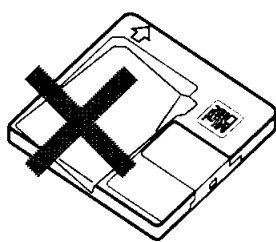

Properly affix the label in its prescribed place.

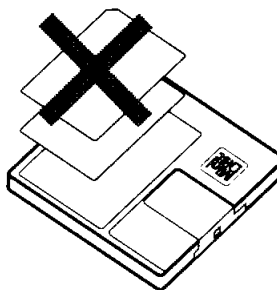

Do not affix a label over another label.

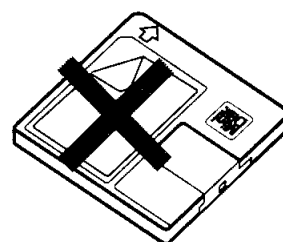

Avoid air bubbles and turned-back corners.

- If the label is not properly affixed, peel it off carefully and affix it properly.

What appears to be a malfunction may not always be serious. If your unit should not perform as expected, consult the table below to see if the problem can be corrected before seeking help from your dealer or service representative.

## Troubleshooting

Symptom	Cause	Remedy
Unit fails to turn ON.	<ul style="list-style-type: none"> <li>The disc holder is not securely closed.</li> <li>The battery is depleted.</li> <li>HOLD status is engaged.</li> </ul>	<ul style="list-style-type: none"> <li>Close disc holder securely. (P15)</li> <li>Charge the battery. (P11)</li> <li>Deactivate HOLD status. (P24)</li> </ul>
There is no sound.	<ul style="list-style-type: none"> <li>The volume is at minimum level.</li> <li>The remote control or headphones are disconnected.</li> </ul>	<ul style="list-style-type: none"> <li>Increase the volume. (P16)</li> <li>Insert plug securely. (P14)</li> </ul>
The unit does not respond to key operation.	<ul style="list-style-type: none"> <li>HOLD status is engaged.</li> <li>The battery is depleted.</li> <li>The remote control or headphone plug is not securely inserted.</li> <li>The disc holder is not securely closed.</li> </ul>	<ul style="list-style-type: none"> <li>Deactivate HOLD status. (P24)</li> <li>Charge the battery. (P11)</li> <li>Insert plug securely. (P14)</li> <li>Close disc holder securely. (P15)</li> </ul>
Sound skips.	<ul style="list-style-type: none"> <li>Battery is depleted.</li> <li>The unit is in a place where there is excessive vibration.</li> </ul>	<ul style="list-style-type: none"> <li>Charge the battery. (P11)</li> <li>Move the unit to a place where there is little vibration. Or set to "PS off" . (P26)</li> </ul>
Battery does not charge.	<ul style="list-style-type: none"> <li>You are using commercial rechargeable battery.</li> <li>The unit has become hot because of exposure to direct sunlight etc.</li> <li>You are using another AC adaptor than the accessory adaptor.</li> <li>The AC adaptors has become disconnected.</li> </ul>	<ul style="list-style-type: none"> <li>Use the special rechargeable battery (NB-L9) (P12)</li> <li>Wait until the unit has cooled to normal temperature.</li> <li>Use the accessory AC adaptor.</li> <li>Connect the AC adaptor securely.</li> </ul>

## Meaning of display messages

Message	Meaning	Action
"noDISC"	<ul style="list-style-type: none"> <li>There is no MD in the unit.</li> </ul>	<ul style="list-style-type: none"> <li>Insert a MD into the unit.</li> </ul>
"BLANK"	<ul style="list-style-type: none"> <li>Nothing is recorded on this MD.</li> </ul>	<ul style="list-style-type: none"> <li>Replace the disc with a prerecorded MD when playing it back.</li> </ul>
"ERROR"	<ul style="list-style-type: none"> <li>The * UTOC contents are faulty.</li> <li>The disc is scratched or damaged, so Playback is not possible.</li> </ul>	<ul style="list-style-type: none"> <li>Replace the MD.</li> <li>Replace the MD.</li> </ul>
"HiTEMP"	<ul style="list-style-type: none"> <li>The inside of the unit has become hot during charging.</li> </ul>	<ul style="list-style-type: none"> <li>Wait until the inside of the unit cools down.</li> </ul>

\* UTOC: UTOC (User's Table of Contents) refers to special data put on a recordable MD, other than TOC data. UTOC contains writable data such as number of songs, performance time, and other written data.

## Resetting the unit

The unit may not operate normally due to faulty handling or adverse power current effects caused by impact, excessive static electricity load, or power drop during use. If this occurs, take the following measures.

- ① Pull the AC adaptor out of the power outlet.
- ② Remove the rechargeable battery.
- ③ Wait about 30 seconds.
- ④ Plug the AC adaptor into the power outlet and operate the unit.

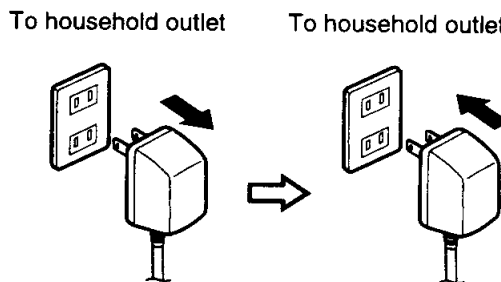

## Operating Tone (Beep)

The operating tone will beep when the following keys are operated. The operating tone can be canceled. →  22

Key	Type of sound
PLAY (▶) key (at the time of power ON)	Short beep, short beep, Short beep
PLAY (▶) key (playback operation)	Short beep, short beep
STOP (■) key	Long beep
SKIP UP (▶▶) key	Short beep, short beep, long beep
SKIP DOWN (◀◀) key	Long beep, Short beep, short beep

# Specifications

DMC-G3 En

System .....	Mini disc digital audio system
Read method .....	Noncontact optical reading system (semiconductor laser)
Sampling frequency .....	44.1 kHz
Audio compression .....	ATRAC (Adaptive Transform Acoustic Coding)
Number of channels .....	2 channels
Frequency response .....	20 Hz to 20,000 Hz ( $\pm 3$ dB)
Wow & flutter .....	Less than unmeasurable limit ( $\pm 0.001$ % W.PEAK)
Input/Output terminal .....	Remote control/Phones jack
Rated power output .....	9 mW + 9 mW (16 $\Omega$ )
Power source .....	DC 5.1 V : AC adaptor (120V AC for U.S.A. and Canada) DC 3.6 V : Lithium ion battery $\times 1$ DC 5 V : Car battery adaptor (sold separately, DC-C60)
Battery life .....	Approx. 9.5 hours (Rechargeable battery)
(Fully charge, with "auto PS" setting ON)	<ul style="list-style-type: none"><li>• At 0.5 mW+0.5 mW output (16 <math>\Omega</math> load)</li><li>• Standard value during continuous use/charging in an ambient temperature of 25°C.</li><li>• Time will be shorter when "PS off" Mode is set.</li></ul>
Dimensions .....	W: 112.6 mm (4-7/16") H : 23.2 mm (15/16") D : 77.9 mm (3-1/16")
Weight (Net) .....	171g (0.38 lb) including the accessory rechargeable battery 123g (0.27 lb) not including the accessory rechargeable battery



1. KENWOOD follows a policy of continuous advancements in development. For reason specifications may be changed without notice.
2. The full performance may not be exhibited in an extremely cold location (under a water-freezing temperature).

**For the U.S.A.****FCC WARNING**

This equipment may generate or use radio frequency energy. Changes or modification of equipment may cause harmful interference unless the modifications are expressly approved in the instruction manual. The user could lose the authority to operate this equipment if an unauthorized change or modification is made.

**NOTE:**

This equipment has been tested and found to comply with the limits for a Class B digital device, pursuant to Part 15 of the FCC Rules. These limits are designed to provide reasonable protection against harmful interference in a residential installation. This equipment may cause harmful interference to radio communications, if it is not installed and used in accordance with the instructions. However, there is no guarantee that interference will not occur in a particular installation. If this equipment does cause harmful interference to radio or television reception, which can be determined by turning the equipment off and on, the user is encouraged to try to correct the interference by one or more of the following measures:

- Reorient or relocate the receiving antenna.
- Increase the separation between the equipment and receiver.
- Connect the equipment into an outlet on a circuit different from that to which the receiver is connected.
- Consult the dealer or an experienced radio/TV technician for help.

**For CANADA****Canadian IC Compliance Notice**

**NOTICE:** This Class B digital apparatus meets all requirements of the Canadian interference-Causisg Equipment Regulations.

**For the U.S.A.****CAUTION:**

Use of controls or adjustments or performance of procedures other than those specified herein may result in hazardous radiation exposure.

In compliance with Federal Regulations, following are reproductions of labels on, or inside the product relating to laser product safety.

KENWOOD CORPORATION  
2967-3, ISHIKAWA-CHO,  
HACHIOJI-SHI,  
TOKYO, JAPAN

KENWOOD CORP. CERTIFIES THIS  
EQUIPMENT CONFORMS TO DHHS  
REGULATIONS NO. 21 CFR 1040.10,  
CHAPTER I, SUBCHAPTER J.

Location: Bottom Panel

---

# KENWOOD

## *For your records*

Record the serial number, found on the back panel of the unit, in the spaces designated on the warranty card, and in the space provided below. Refer to the model and serial numbers whenever you call upon your dealer for information or service on this product.

Model

Serial Number